

2015 NINJA® 300 PARTS DIAGRAM

Oil Pump/Oil Filter

E1710

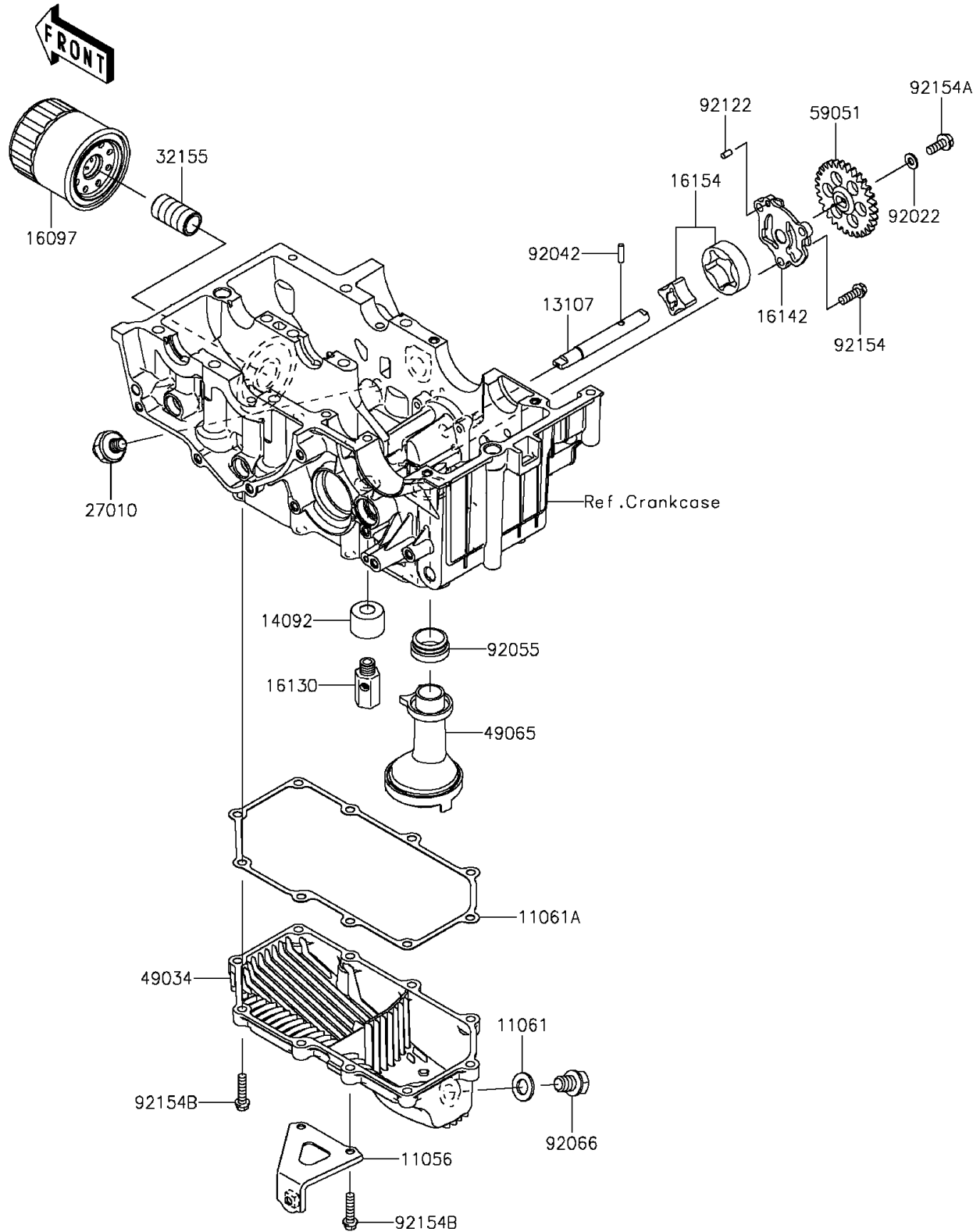

2015 NINJA® 300 PARTS LIST

Oil Pump/Oil Filter

ITEM NAME	PART NUMBER	QUANTITY
BRACKET (Ref # 11056)	11056-1640	1
GASKET,12X22X2 (Ref # 11061)	11061-0417	1
GASKET,OIL PAN (Ref # 11061A)	11061-0794	1
SHAFT (Ref # 13107)	13107-0741	1
COVER,RELIEF VALVE (Ref # 14092)	14092-1002	1
FILTER-ASSY-OIL (Ref # 16097)	16097-0008	1
VALVE-ASSY-RELIEF (Ref # 16130)	16130-0002	1
COVER-PUMP (Ref # 16142)	16142-0707	1
ROTOR-PUMP (Ref # 16154)	16154-0711	1
SWITCH,OIL PRESSURE (Ref # 27010)	27010-1313	1
PIPE,OIL FILTER (Ref # 32155)	32155-0029	1
PAN-OIL (Ref # 49034)	49034-0553	1
FILTER-OIL (Ref # 49065)	49065-0711	1
GEAR-SPUR,30T (Ref # 59051)	59051-0721	1
WASHER,6X12.8X1.2 (Ref # 92022)	92022-1827	1
PIN,DOWEL,4X15.8 (Ref # 92042)	92042-014	1
RING-O,OIL FILTER (Ref # 92055)	92055-1354	1
PLUG,OIL DRAIN,12X15 (Ref # 92066)	92066-0767	1
ROLLER,4X8 (Ref # 92122)	92122-0557	1
BOLT,FLANGED,6X18 (Ref # 92154)	92154-0784	1
BOLT,FLANGED,6X16 (Ref # 92154A)	92154-1055	1
BOLT,FLANGED,6X25 (Ref # 92154B)	92154-1212	1