

2015 NINJA® 300 PARTS DIAGRAM

Crankcase

E1411

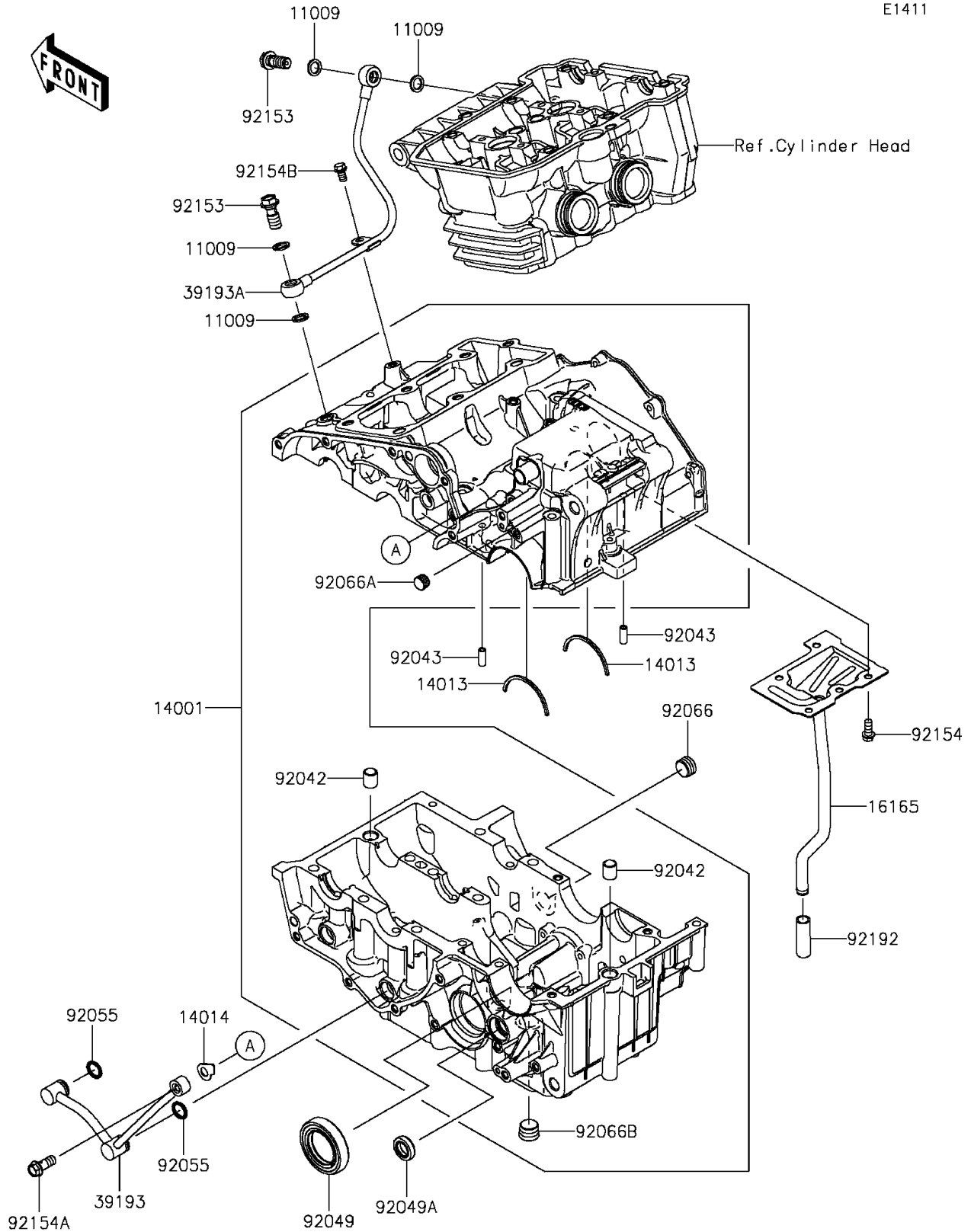

2015 NINJA® 300 PARTS LIST

Crankcase

ITEM NAME	PART NUMBER	QUANTITY
GASKET,10X14.5X1.5 (Ref # 11009)	11009-1105	1
SET-CRANKCASE (Ref # 14001)	14001-0610	1
RING-POSITION (Ref # 14013)	14013-004	1
PLATE-POSITION (Ref # 14014)	14014-0565	1
SEPARATOR (Ref # 16165)	16165-0010	1
PIPE-OIL (Ref # 39193)	39193-0571	1
PIPE-OIL,CASE-HEAD (Ref # 39193A)	39193-0572	1
PIN,DOWEL,12X14 (Ref # 92042)	92042-031	1
PIN,3.5X6X16 (Ref # 92043)	92043-1309	1
SEAL-OIL,32X52X10 (Ref # 92049)	92049-0731	1
SEAL-OIL (Ref # 92049A)	92049-1559	1
RING-O,11.8X2.4 (Ref # 92055)	92055-0733	1
PLUG,PT3/8X10 (Ref # 92066)	92066-0003	1
PLUG (Ref # 92066A)	92066-1110	1
PLUG,PT3/8X12 (Ref # 92066B)	92066-1252	1
BOLT,OIL,L=23 (Ref # 92153)	92153-0627	1
BOLT,FLANGED,6X14 (Ref # 92154)	92154-0777	1
BOLT,FLANGED,8X20 (Ref # 92154A)	92154-0957	1
BOLT,FLANGED,6X10 (Ref # 92154B)	92154-1065	1
TUBE,9X12X38 (Ref # 92192)	92192-0225	1