

## 2008 NINJA® ZX™-10R PARTS DIAGRAM

Tires(CA,US)

F2210

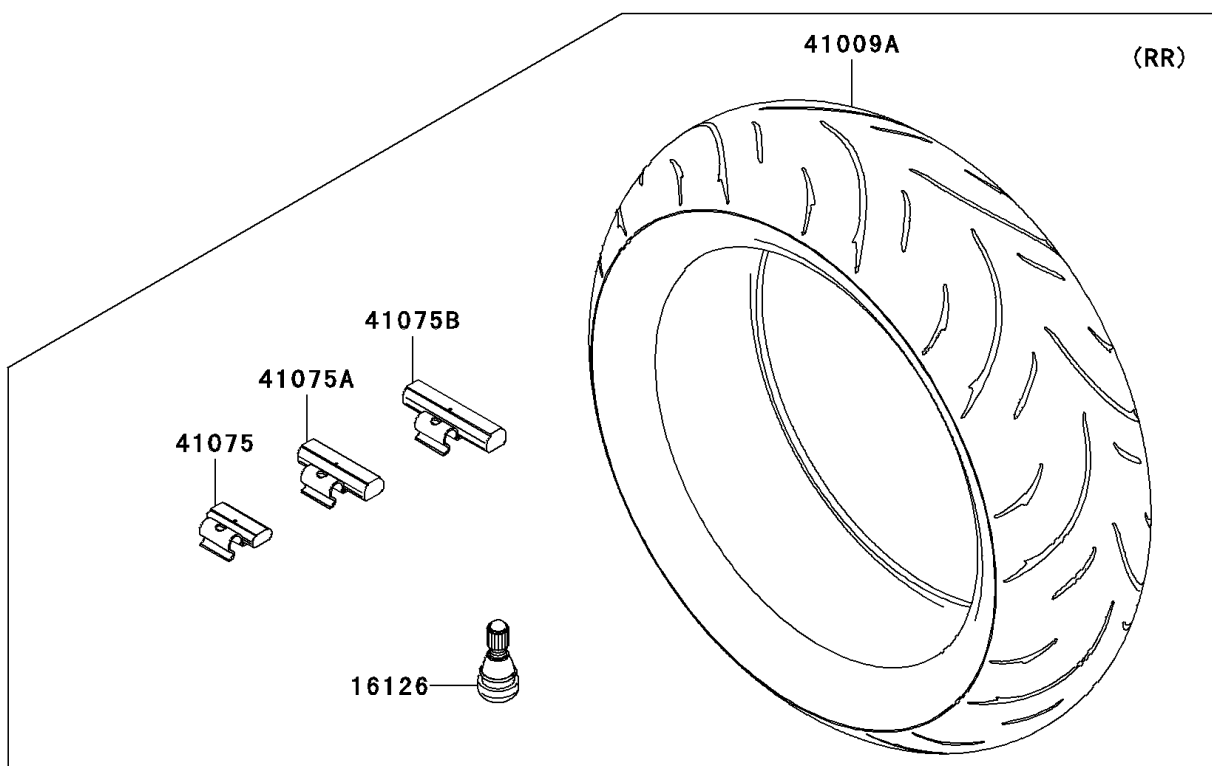
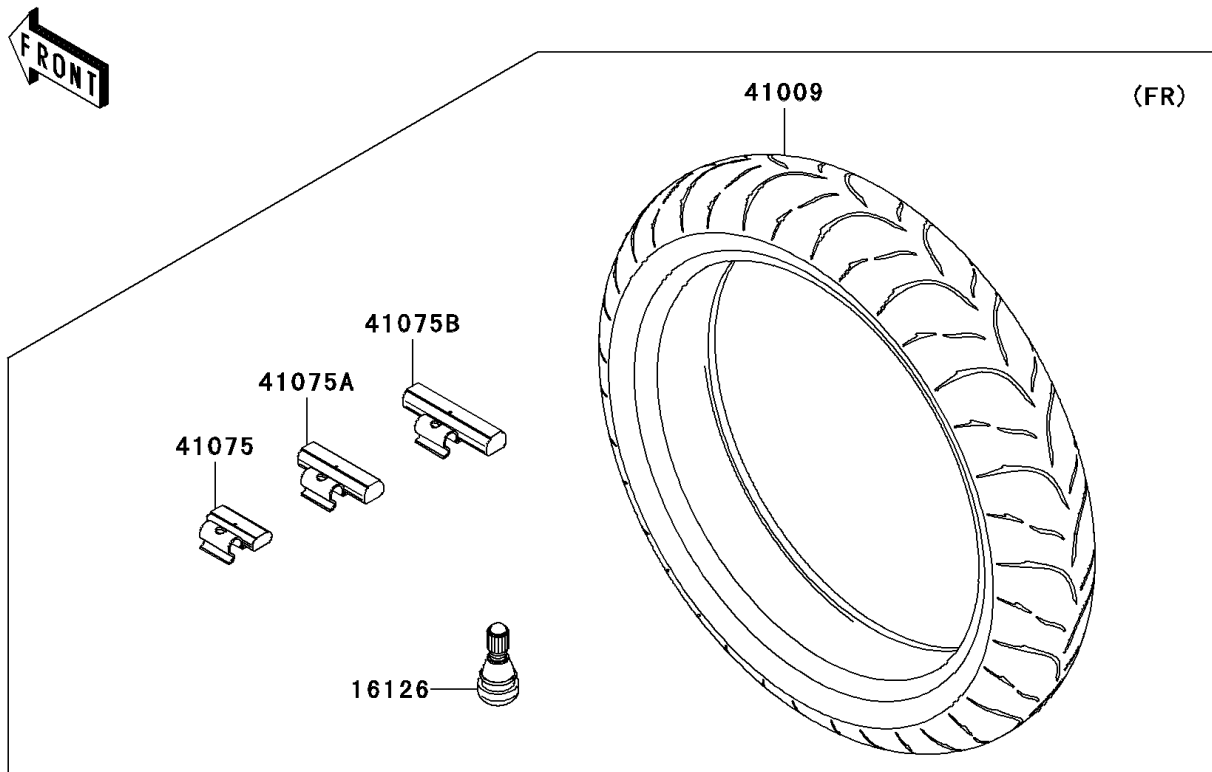

## 2008 NINJA® ZX™-10R PARTS LIST

Tires(CA,US)

ITEM NAME	PART NUMBER	QUANTITY
VALVE,TIRE (Ref # 16126)	16126-1140	1
TIRE,FR,120/70ZR17(58W),BT016F (Ref # 41009)	41009-0177	1
TIRE,RR,190/55ZR17(75W),BT016R (Ref # 41009A)	41009-0178	1
BALANCER-WHEEL,10G,SILVER (Ref # 41075)	41075-0007	1
BALANCER-WHEEL,20G,SILVER (Ref # 41075A)	41075-0008	1
BALANCER-WHEEL,30G,SILVER (Ref # 41075B)	41075-0009	1