

2009 PARTS DIAGRAM

Crankcase

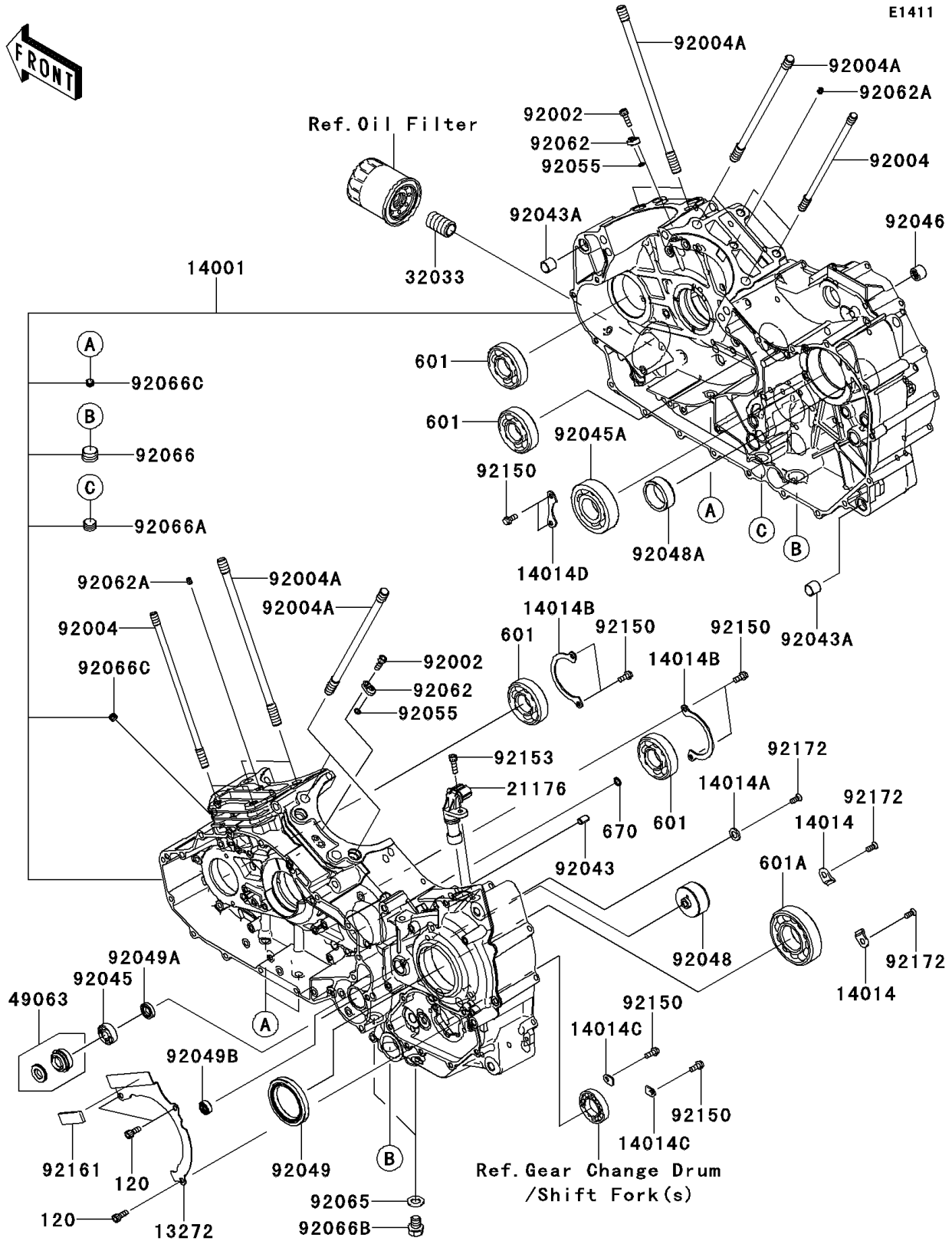

2009 PARTS LIST

Crankcase

ITEM NAME	PART NUMBER	QUANTITY
BOLT-SOCKET,6X16 (Ref # 120)	120CA0616	1
BEARING-BALL,#6305 (Ref # 601)	601A6305	1
BEARING-BALL (Ref # 601A)	601A6307	1
O RING,8MM (Ref # 670)	670D1508	1
PLATE,EG OUTPUT (Ref # 13272)	13272-0319	1
SET-CRANKCASE (Ref # 14001)	14001-0134	1
PLATE-POSITION (Ref # 14014)	14014-0003	1
PLATE-POSITION,9.5X17X2.3 (Ref # 14014A)	14014-0019	1
PLATE-POSITION,BALANCER (Ref # 14014B)	14014-0033	1
PLATE-POSITION,CHANGE DRUM (Ref # 14014C)	14014-0034	1
PLATE-POSITION (Ref # 14014D)	14014-1084	1
SENSOR,SPEED (Ref # 21176)	21176-0042	1
PIPE,OIL FILTER (Ref # 32033)	32033-1535	1
SEAL-MECHANICAL,WATER (Ref # 49063)	49063-1055	1
BOLT,SOCKET,5X18 (Ref # 92002)	92002-1805	1
STUD,10X201 (Ref # 92004)	92004-0038	1
STUD,12X217 (Ref # 92004A)	92004-0039	1
PIN,6.2X8X14 (Ref # 92043)	92043-1263	1
PIN,13X16X14 (Ref # 92043A)	92043-1608	1
BEARING-BALL,6001JRXLLU/5K (Ref # 92045)	92045-1151	1
BEARING-BALL,6306SH2 (Ref # 92045A)	92045-1190	1
BEARING-NEEDLE,HK1212V11 (Ref # 92046)	92046-1292	1
RACE (Ref # 92048)	92048-0017	1
RACE (Ref # 92048A)	92048-1103	1
SEAL-OIL,50X68X9 (Ref # 92049)	92049-0107	1
SEAL-OIL,SC 12X22X5 (Ref # 92049A)	92049-1228	1
SEAL-OIL (Ref # 92049B)	92049-1566	1
RING-O,5.5X1.5 (Ref # 92055)	92055-1339	1
NOZZLE,OIL JET (Ref # 92062)	92062-0016	1

2009 PARTS LIST

Crankcase

ITEM NAME	PART NUMBER	QUANTITY
NOZZLE,6X8,YELLOW (Ref # 92062A)	92062-1080	1
GASKET,12X22X2 (Ref # 92065)	92065-097	1
PLUG,PT1/2X12.5 (Ref # 92066)	92066-0002	1
PLUG,PT3/8X10 (Ref # 92066A)	92066-0003	1
PLUG,12X15 (Ref # 92066B)	92066-0079	1
PLUG,PT1/8X7 (Ref # 92066C)	92066-1227	1
BOLT,6X14 (Ref # 92150)	92150-1916	1
BOLT,SOCKET,6X20 (Ref # 92153)	92153-1031	1
DAMPER (Ref # 92161)	92161-0124	1
SCREW,6X14 (Ref # 92172)	92172-0187	1