

2008 Concours™ 14 PARTS DIAGRAM

Crankcase

E1411

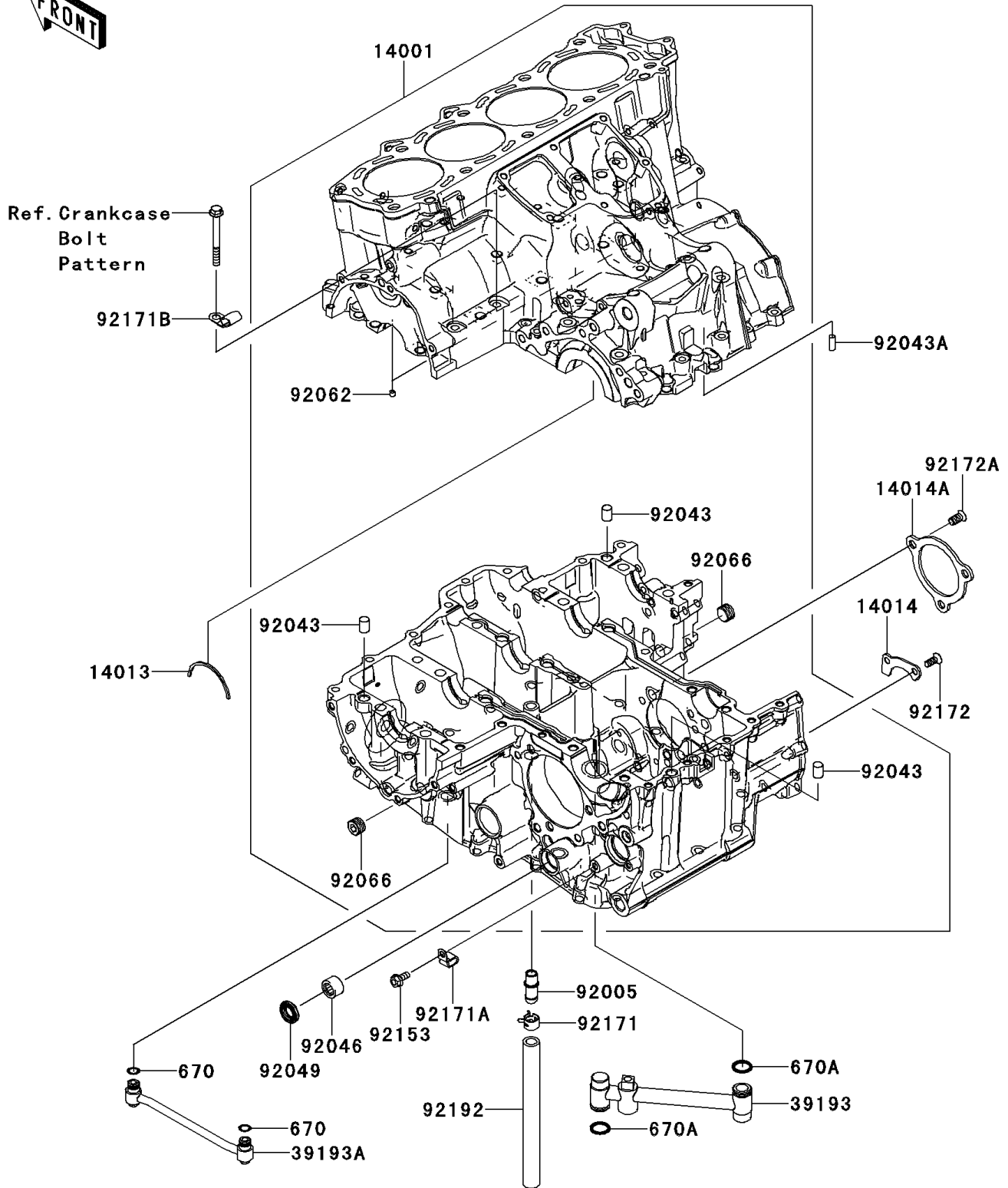

2008 Concours™ 14 PARTS LIST

Crankcase

ITEM NAME	PART NUMBER	QUANTITY
O RING,9MM (Ref # 670)	670D1509	1
O RING,16MM (Ref # 670A)	670D2016	1
SET-CRANKCASE (Ref # 14001)	14001-0127	1
RING-POSITION (Ref # 14013)	14013-1051	1
PLATE-POSITION (Ref # 14014)	14014-0023	1
PLATE-POSITION (Ref # 14014A)	14014-0032	1
PIPE-OIL (Ref # 39193)	39193-0034	1
PIPE-OIL (Ref # 39193A)	39193-0043	1
FITTING (Ref # 92005)	92005-0043	1
PIN,10X14 (Ref # 92043)	92043-1506	1
PIN,6X16 (Ref # 92043A)	92043-1690	1
BEARING-NEEDLE,7E-HK1412 (Ref # 92046)	92046-037	1
SEAL-OIL,TC14245 (Ref # 92049)	92049-1520	1
NOZZLE (Ref # 92062)	92062-0010	1
PLUG (Ref # 92066)	92066-0064	1
BOLT-FLANGED,6X14 (Ref # 92153)	92153-1571	1
CLAMP (Ref # 92171)	92171-0533	1
CLAMP (Ref # 92171A)	92171-0534	1
CLAMP (Ref # 92171B)	92171-0689	1
SCREW,6X16 (Ref # 92172)	92172-0218	1
SCREW,CSK-CROS,8X16 (Ref # 92172A)	92172-0323	1
TUBE,11X17X180 (Ref # 92192)	92192-0254	1