

2001 NINJA® ZX™-12R PARTS DIAGRAM

Oil Pan

E1434

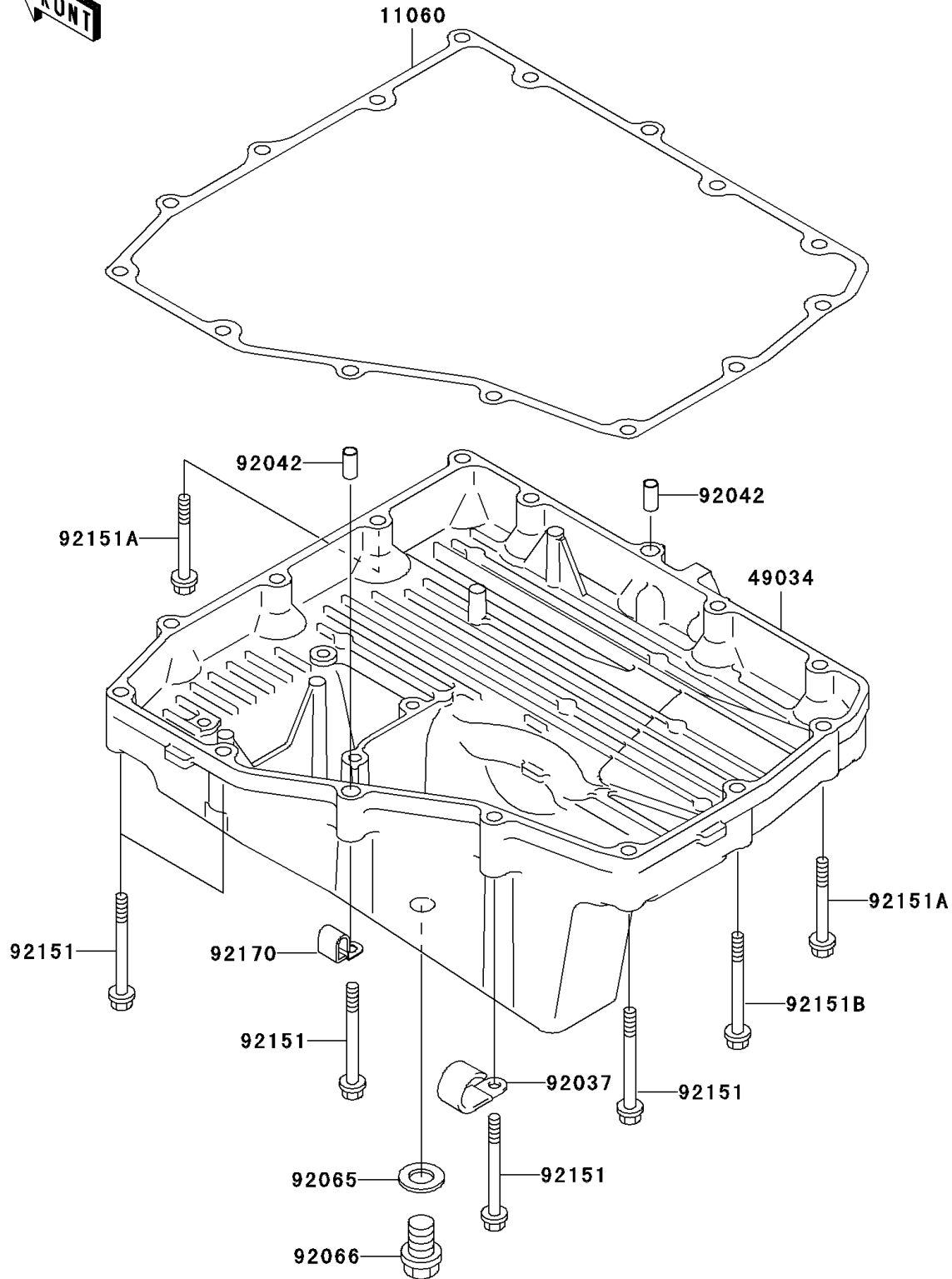

2001 NINJA® ZX™-12R PARTS LIST

Oil Pan

ITEM NAME	PART NUMBER	QUANTITY
GASKET,OIL PAN (Ref # 11060)	11060-1909	1
PAN-OIL (Ref # 49034)	49034-1136	1
CLAMP,WIRING HARNESS (Ref # 92037)	92037-1877	1
PIN,DOWEL,6.3X8X14 (Ref # 92042)	92042-007	1
GASKET,12X22X2,DRAIN PLUG (Ref # 92065)	92065-097	1
PLUG,OIL DRAIN,12X15 (Ref # 92066)	92066-1174	1
BOLT,6X45 (Ref # 92151)	92151-1521	1
BOLT,6X40 (Ref # 92151A)	92151-1583	1
BOLT,6X45 (Ref # 92151B)	92151-1888	1
CLAMP (Ref # 92170)	92170-1577	1