

1966 W1 PARTS DIAGRAM

SWING ARM/SHOCK ABSORBERS

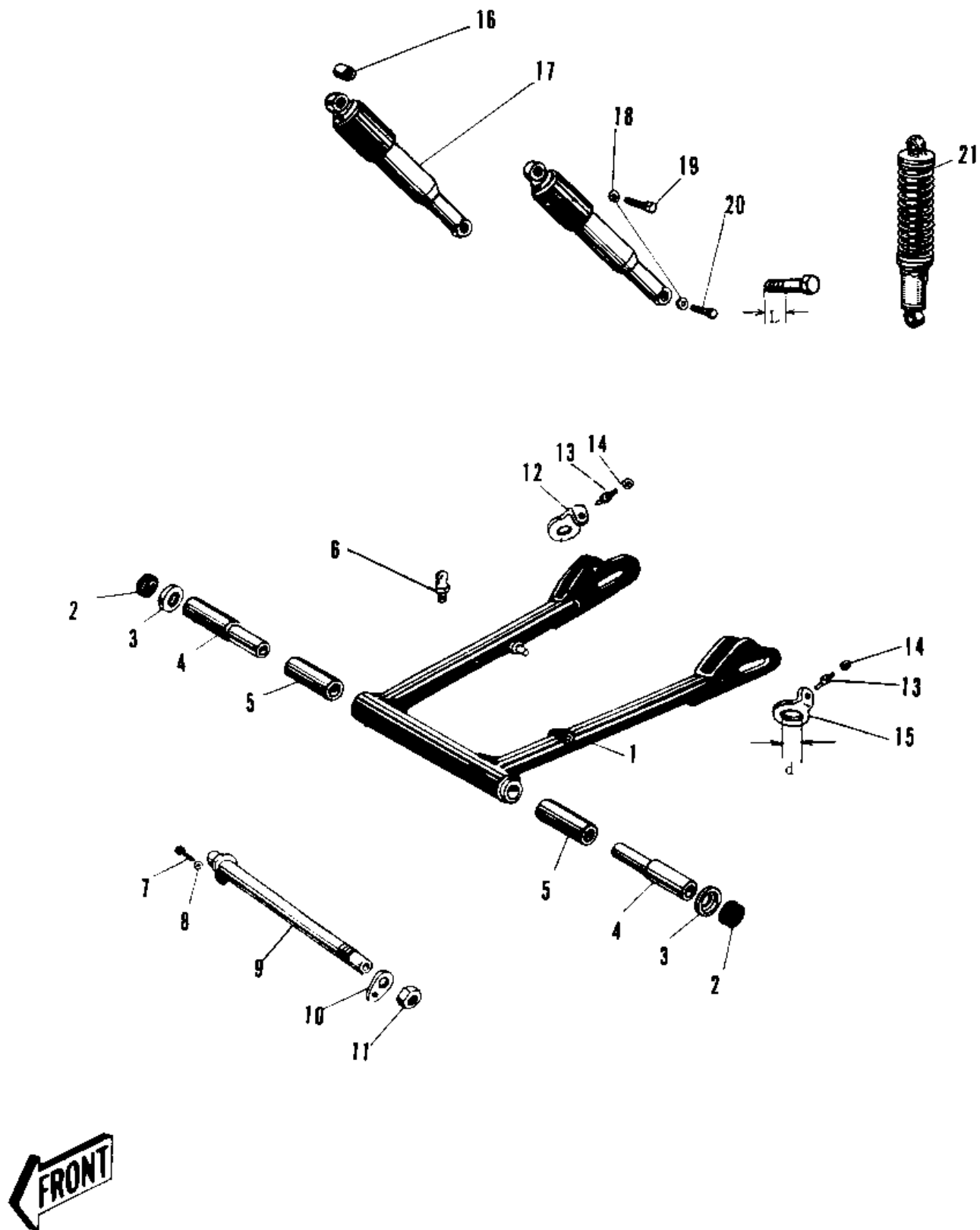

1966 W1 PARTS LIST

SWING ARM/SHOCK ABSORBERS

ITEM NAME	PART NUMBER	QUANTITY
ARM SWING (Ref # 1)	33001-005	1
DUST SHIELD PIVOT SHT (Ref # 2)	92093-005	1
HOLDER PV SHT DST SHD (Ref # 3)	33035-002	1
SLEEVE PIVOT SHAFT (Ref # 4)	33034-005	1
BUSH SWING ARM PIVOT (Ref # 5)	33033-003	1
GREASE NIPPLE (Ref # 6)	92005-002	1
BOLT-UPSET,6X12 (Ref # 7)	112G0612	1
WASHER SPRING 6MM (Ref # 8)	461F0600	1
SHAFT SWING ARM PIVOT (Ref # 9)	33032-019	1
WASHER SWING ARM SHT (Ref # 10)	33037-002	1
NUT SWING ARM PV SHT (Ref # 11)	92016-022	1
ADJUSTER CHAIN R.H (Ref # 12)	33040-026	1
BOLT CHAIN ADJUSTER (Ref # 13)	92001-045	1
NUT 8MM (Ref # 14)	314B0800	1
ADJUSTER CHAIN L.H (Ref # 15)	33040-025	1
BUSH SHCK ABS RUBBER (Ref # 16)	45017-001	1
UNAVAILABLE IN PRICE BOOK (Ref # 17)	45014-029	1
SHOCK ABSBR RR (Ref # 17)	45014-041	1
WASHER SPRING 10MM (Ref # 18)	461F1000	1
BOLT RR SHOCK ABSRBR (Ref # 19)	92007-017	1
BOLT HEX HEAD 10X38 (Ref # 20)	113N1038	1