

1980 KZ250 PARTS DIAGRAM

GEAR CHANGE DRUM & FORKS ('80 D1)

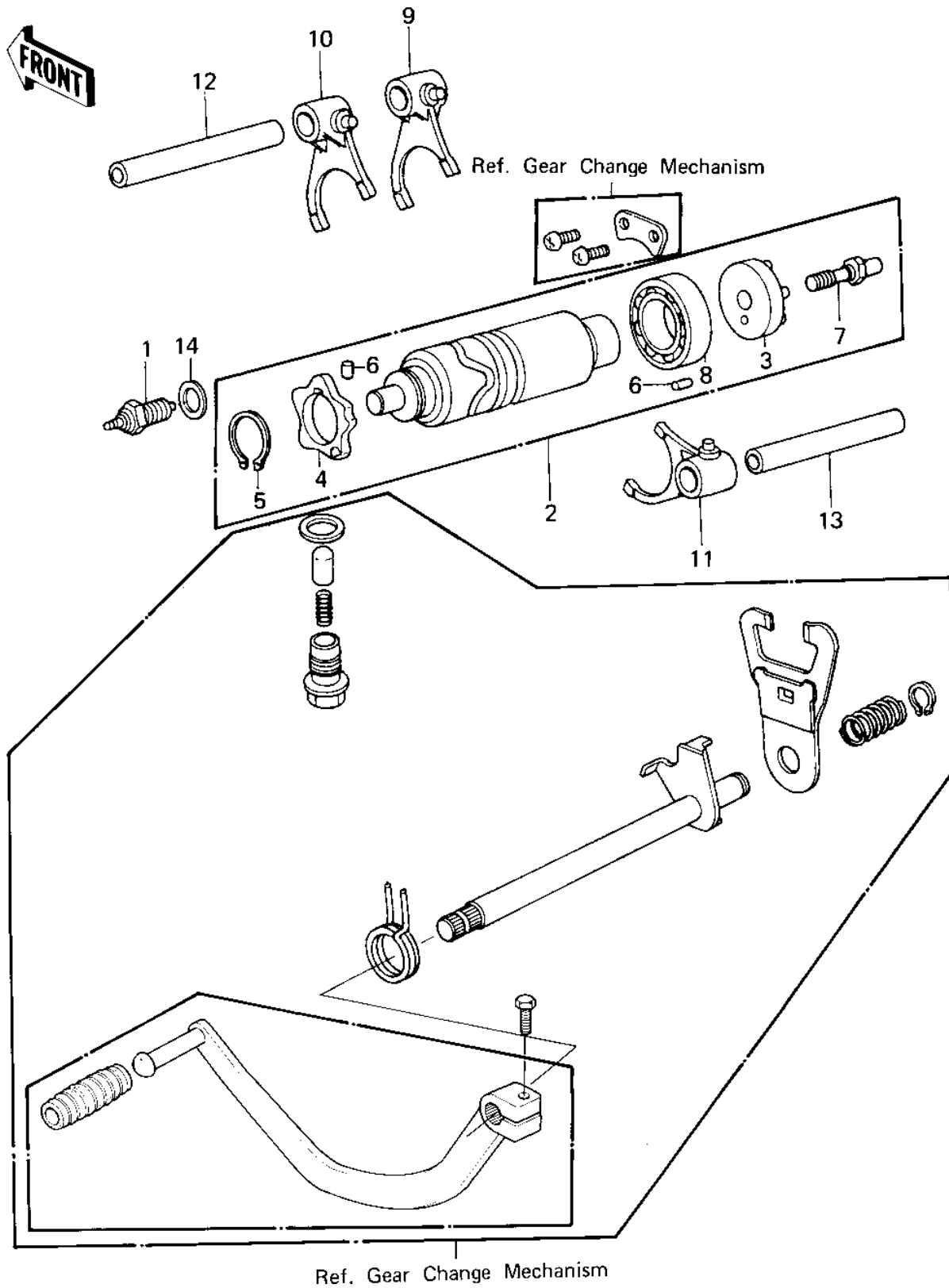

1980 KZ250 PARTS LIST

GEAR CHANGE DRUM & FORKS ('80 D1)

ITEM NAME	PART NUMBER	QUANTITY
SWITCH,NEUTRAL (Ref # 1)	13151-1007	1
DRUM ASSY,GEAR SHIFT (Ref # 2)	13239-1036	1
PLATE,GEAR CHANGE (Ref # 3)	13142-019	1
DISK,SHIFT DRUM (Ref # 4)	13145-1002	1
CIRCLIP 24MM (Ref # 5)	480J2400	1
PIN-DOWEL,4X6 (Ref # 6)	610A0406	1
BOLT (Ref # 7)	92001-166	1
BEARING,BALL,#6905 (Ref # 8)	92045-036	1
SHIFT FORK,LOW (Ref # 9)	13140-073	1
SHIFT FORK,2ND&3RD (Ref # 10)	13140-074	1
SHIFT FORK,4TH&TOP (Ref # 11)	13140-075	1
ROD,SHIFT 93.7M/M (Ref # 12)	49047-1003	1
ROD,SHIFT 71.7M/M (Ref # 13)	49047-1002	1
GASKET CHECK VALVE (Ref # 14)	92065-058	1