

1972 PARTS DIAGRAM

KICKSTARTER MECHANISM ('76-'80)

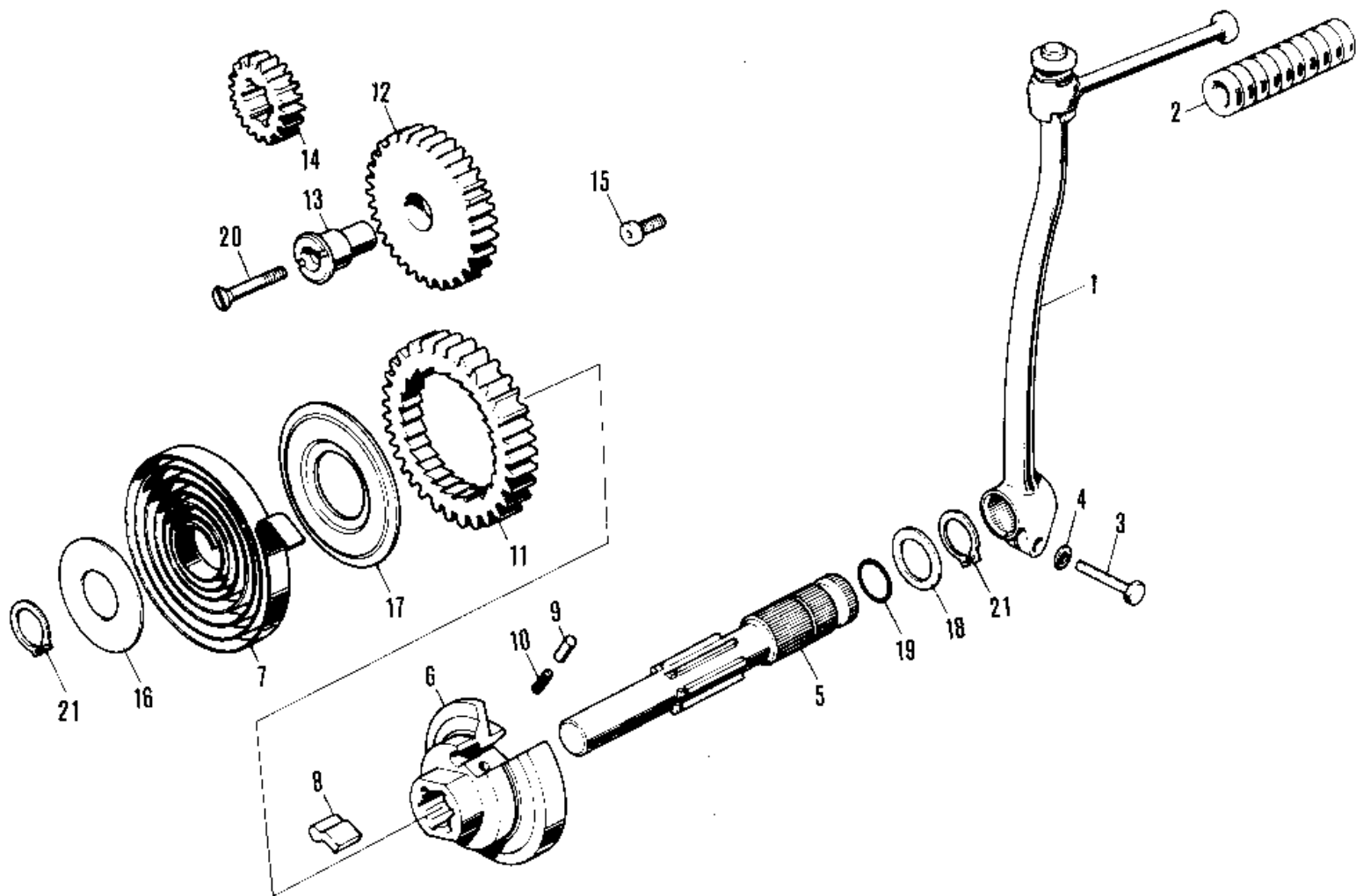

1972 PARTS LIST

KICKSTARTER MECHANISM ('76-'80)

ITEM NAME	PART NUMBER	QUANTITY
PEDAL-KICKSTARTER (Ref # 1)	13058-031	1
RUBBER-KICK PEDAL (Ref # 2)	13063-005	1
BOLT-UPSET (Ref # 3)	112G0625	1
WASHER SPRING 6MM (Ref # 4)	461F0600	1
SHAFT-KICKSTARTER (Ref # 5)	13066-018	1
DRUM KK (Ref # 6)	13067-001	1
KICKSTARTER SPRING (Ref # 7)	92082-001	1
PAWL (Ref # 8)	13069-001	1
PIN KICKSTARTER PAWL (Ref # 9)	92042-001	1
SPRING KICK PAWL (Ref # 10)	92081-022	1
GEAR-KICKSTARTER (Ref # 11)	13068-003	1
IDLE GEAR (Ref # 12)	13073-002	1
SHAFT-IDLE GEAR (Ref # 13)	13074-002	1
PINION-KICKSTARTER (Ref # 14)	13075-003	1
STOPPER-KICKSTARTER (Ref # 15)	13072-001	1
PLATE-KICK SPRG HLDER (Ref # 16)	13071-001	1
PLATE-KICK GEAR HLDER (Ref # 17)	13071-002	1
WASHER,16MM (Ref # 18)	92022-006	1
"O" RING,16MM (Ref # 19)	92055-001	1
SCREW,CNTSNK,5X30.5 (Ref # 20)	92010-002	1
CIRCLIP 16MM (Ref # 21)	480J1600	1