

1986 NINJA® 250R PARTS DIAGRAM

GEAR CHANGE MECHANISM

E1370-0163

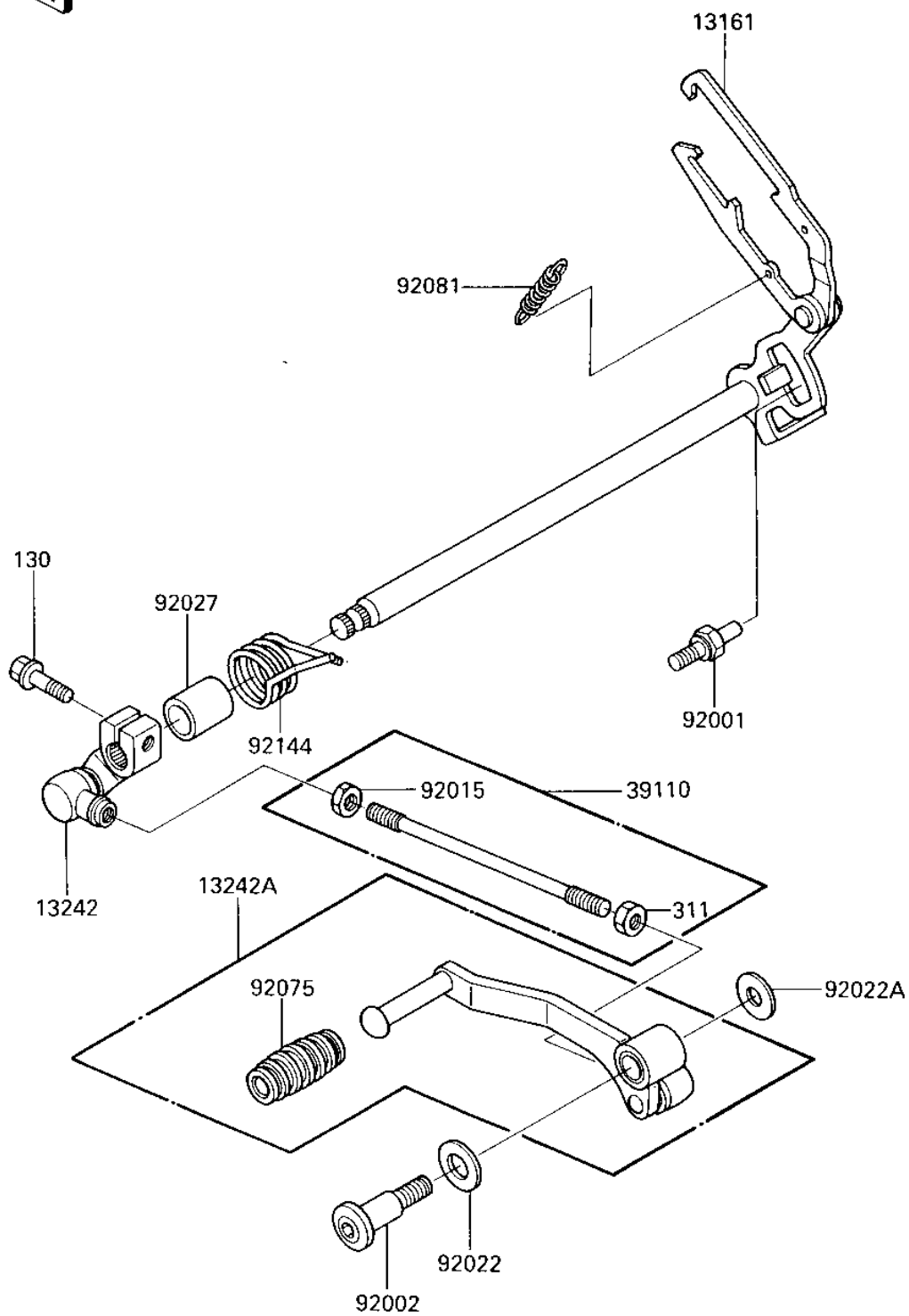

1986 NINJA® 250R PARTS LIST

GEAR CHANGE MECHANISM

ITEM NAME	PART NUMBER	QUANTITY
LEVER-COMP-CHANGE SHA (Ref # 13161)	13161-1131	1
LEVER-ASSY-CHANGE (Ref # 13242)	13242-1214	1
LEVER-ASSY-CHANGE,PED (Ref # 13242A)	13242-1215	1
ROD-ASSY-TIE (Ref # 39110)	39110-1064	1
BOLT,RETURN SPRING (Ref # 92001)	92001-1401	1
BOLT,CHANGE PEDAL (Ref # 92002)	92002-1926	1
NUT (Ref # 92015)	92015-1178	1
WASHER PLAIN 12MM (Ref # 92022)	92022-072	1
WASHER,8.5X20X1.6 (Ref # 92022A)	92022-1561	1
COLLAR,13X18.3X21.5 (Ref # 92027)	92027-1440	1
DAMPER,CHANGE PEDAL (Ref # 92075)	92160-1036	1
SPRING-CHANGE LEVER (Ref # 92081)	92081-076	1
SPRING,CHANGE PEDAL R (Ref # 92144)	92144-1074	1
BOLT-FLANGED,6X20,BLA (Ref # 130)	130S0620	1
NUT-HEX (Ref # 311)	311J0600	1