

2008 Teryx® 750 4x4 NRA Outdoors™ PARTS DIAGRAM

Engine Mount

F2122

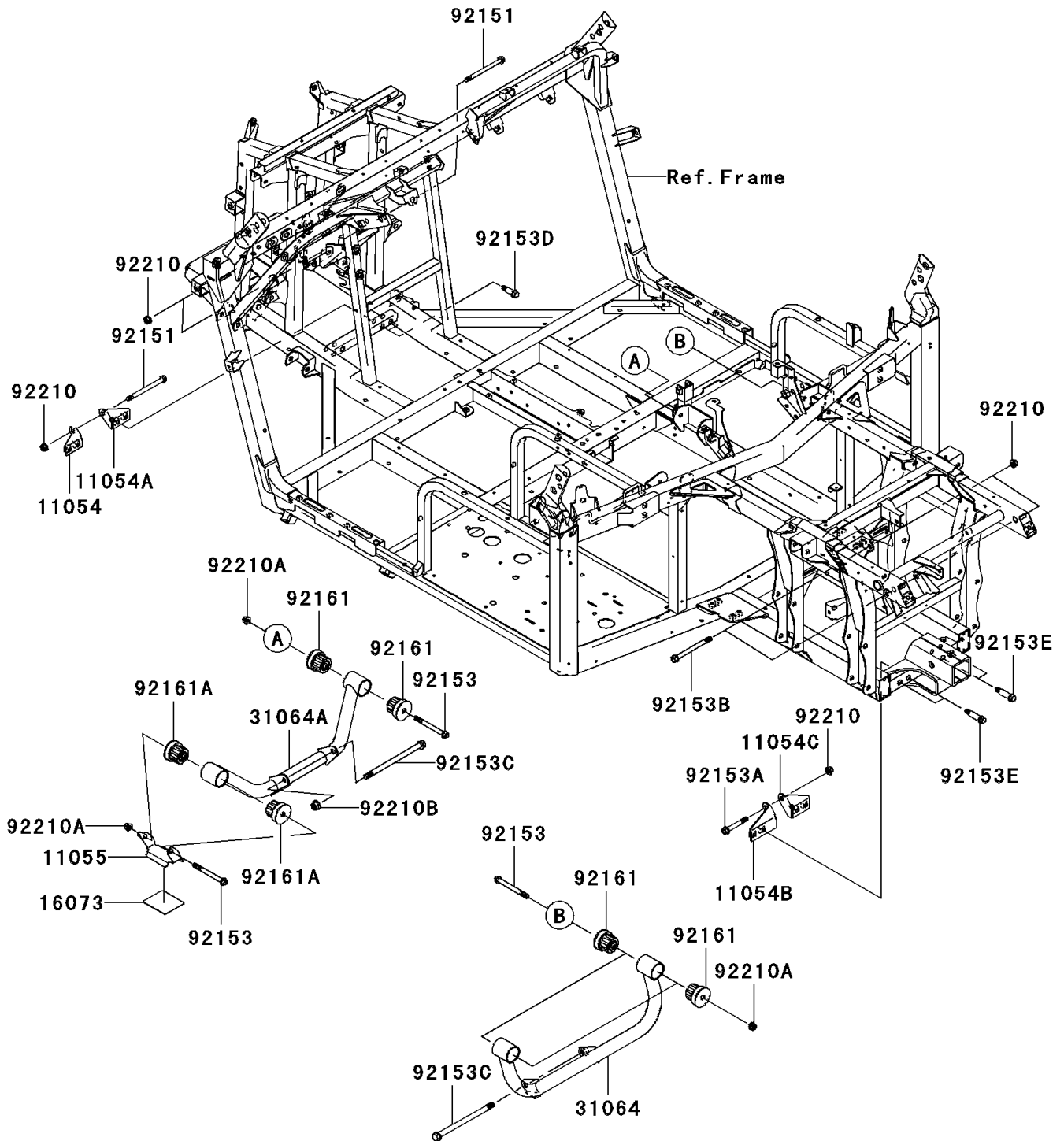

2008 Teryx® 750 4x4 NRA Outdoors™ PARTS LIST

Engine Mount

ITEM NAME	PART NUMBER	QUANTITY
BRACKET,FRONT DIFF,LH (Ref # 11054)	11054-1045	1
BRACKET,FRONT DIFF,RH (Ref # 11054A)	11054-1046	1
BRACKET,REAR DIFF,LH (Ref # 11054B)	11054-1047	1
BRACKET,REAR DIFF,RH (Ref # 11054C)	11054-1048	1
BRACKET (Ref # 11055)	11055-1127	1
INSULATOR (Ref # 16073)	16073-0061	1
PIPE-COMP,RR (Ref # 31064)	31064-0082	1
PIPE-COMP,FR (Ref # 31064A)	31064-0100	1
BOLT,FLANGED,10X120 (Ref # 92151)	92151-1914	1
BOLT,FLANGED,10X100 (Ref # 92153)	92153-0307	1
BOLT,FLANGED,10X70 (Ref # 92153A)	92153-0871	1
BOLT,FLANGED,10X120 (Ref # 92153B)	92153-0872	1
BOLT,FLANGED,12X190 (Ref # 92153C)	92153-1272	1
BOLT,FLANGED,10X38 (Ref # 92153D)	92153-1742	1
BOLT,FLANGED,10X51 (Ref # 92153E)	92153-1743	1
DAMPER (Ref # 92161)	92161-0423	1
DAMPER (Ref # 92161A)	92161-0571	1
NUT,LOCK,FLANGED,10MM (Ref # 92210)	92210-1081	1
NUT,LOCK,FLANGED,10MM (Ref # 92210A)	92210-1139	1
NUT,LOCK,FLANGED,12MM (Ref # 92210B)	92210-1150	1