

1984 1100 LTD Shaft PARTS DIAGRAM

GEAR CHANGE DRUM & FORKS

E1362-0070

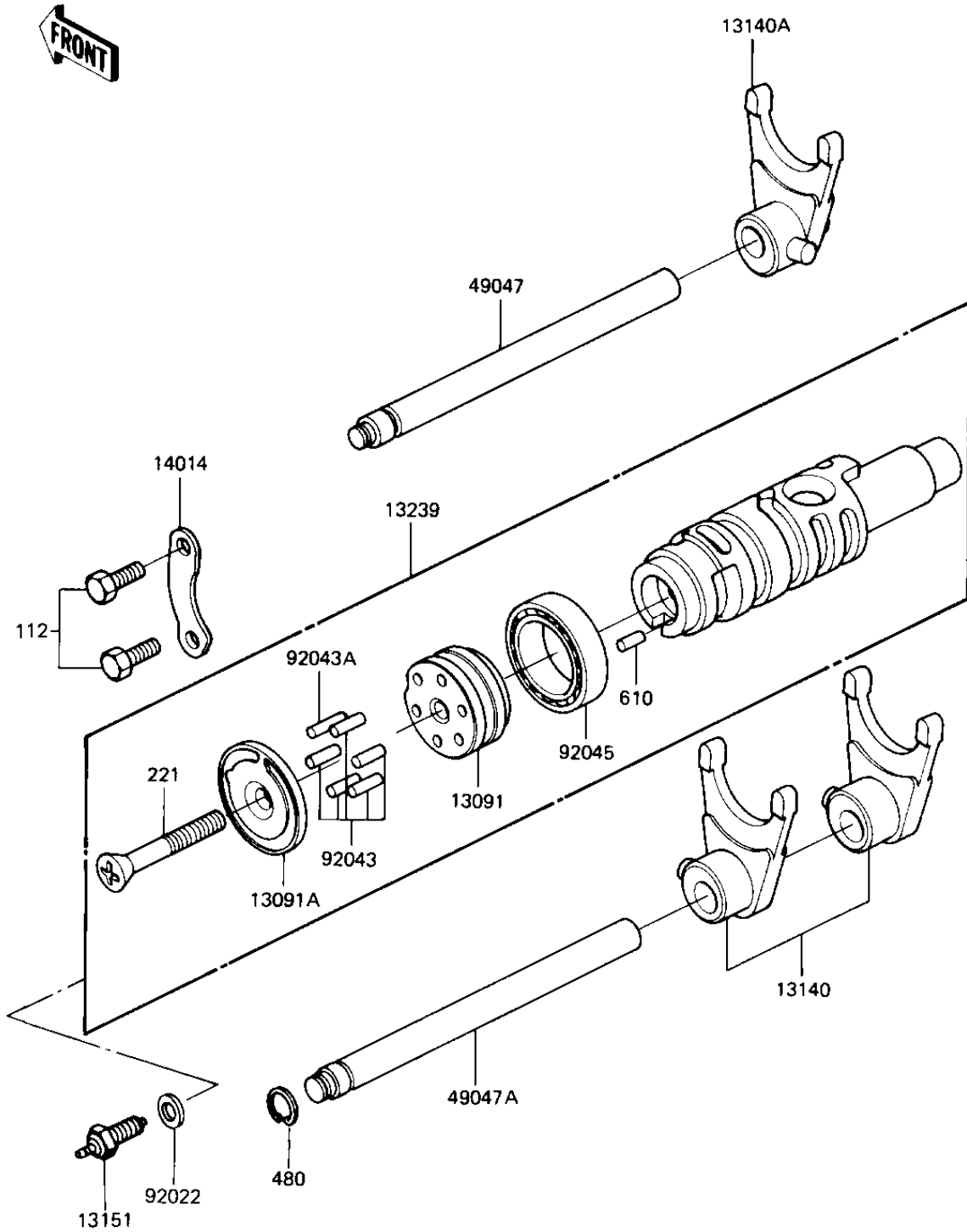

1984 1100 LTD Shaft PARTS LIST

GEAR CHANGE DRUM & FORKS

ITEM NAME	PART NUMBER	QUANTITY
HOLDER,CHANGE DRM PIN (Ref # 13091)	13091-1103	1
HOLDER,CHANGE DRUM PI (Ref # 13091A)	13091-1104	1
FORK-SHIFT (Ref # 13140)	13140-1045	1
FORK-SHIFT (Ref # 13140A)	13140-1046	1
SWITCH,NEUTRAL (Ref # 13151)	13151-1007	1
DRUM-ASSY-CHANGE (Ref # 13239)	13239-1108	1
PLATE-POSITION (Ref # 14014)	14014-1015	1
ROD-SHIFT (Ref # 49047)	49047-1014	1
ROD-SHIFT (Ref # 49047A)	49047-1019	1
GASKET CHECK VALVE (Ref # 92022)	92065-058	1
PIN GEAR CHANGE DRUM (Ref # 92043)	92042-014	1
PIN-CHANGE DRUM (Ref # 92043A)	92042-020	1
BEARING-BALL,6806 (Ref # 92045)	92045-1035	1
BOLT-UPSET,6X16 (Ref # 112)	112G0616	1
SCREW-CSK-CROS,6X45 (Ref # 221)	221B0645	1
CIRCLIP 12MM (Ref # 480)	480J1200	1
PIN DOWEL 4X10 (Ref # 610)	610A0410	1