

1983 KLT200 PARTS DIAGRAM

GEAR CHANGE MECHANISM

E1370-0093

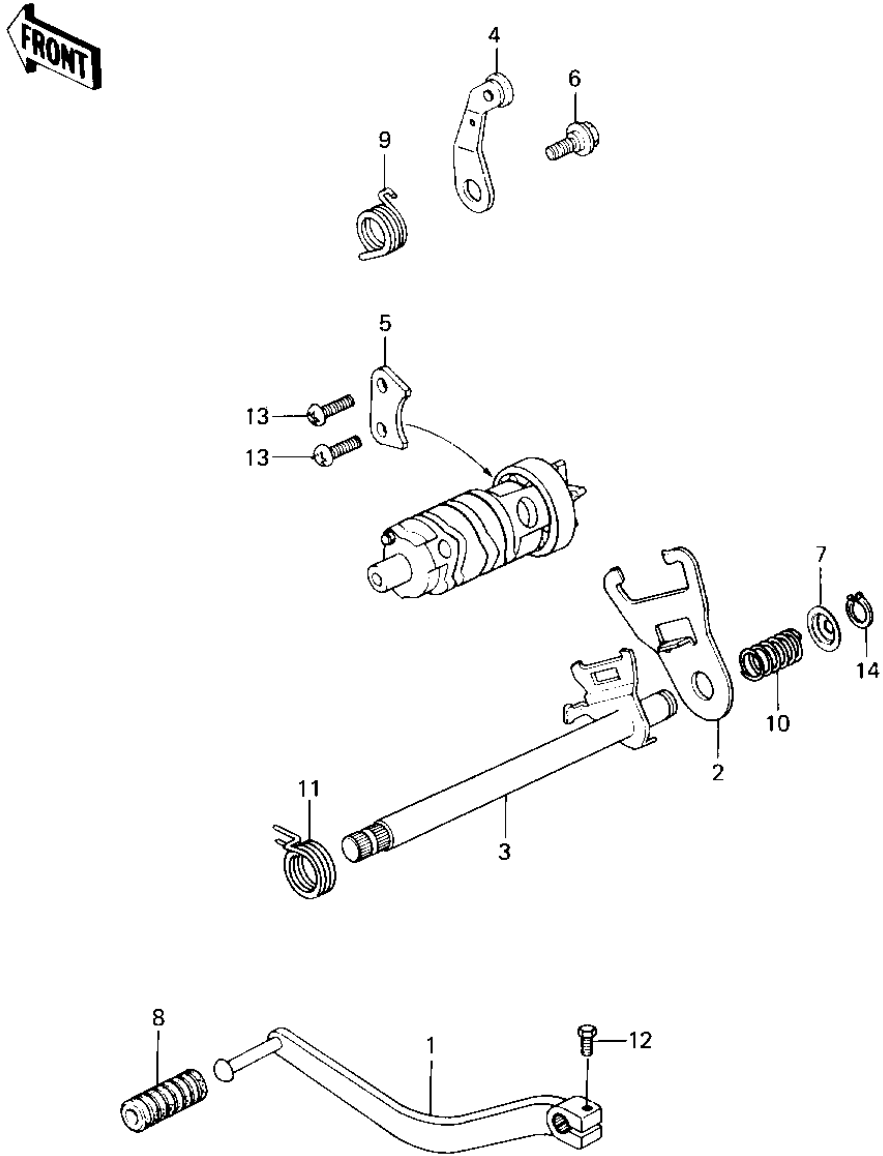

1983 KLT200 PARTS LIST

GEAR CHANGE MECHANISM

ITEM NAME	PART NUMBER	QUANTITY
LEVER,GEAR SHIFT (Ref # 1)	13156-1070	1
LEVER-CHANGE (Ref # 2)	13156-1122	1
LEVER-COMP-CHANGE SHA (Ref # 3)	13161-1046	1
LEVER,GEAR CHANGE (Ref # 4)	13168-1129	1
PLATE,GEAR CHANGE (Ref # 5)	13169-014	1
BOLT (Ref # 6)	92001-1715	1
WASHER,CHANGE LEVER (Ref # 7)	92022-1406	1
DAMPER,CHANGE PEDAL (Ref # 8)	92160-1108	1
SPRING (Ref # 9)	92081-1496	1
SPRING,CHANGE REVER (Ref # 10)	92081-1536	1
SPRING,CHG PEDL RTRN (Ref # 11)	92083-028	1
BOLT,8X20 (Ref # 12)	115G0820	1
SCREW PAN HEAD 6X14 (Ref # 13)	220B0614	1
CIRCLIP,13MM (Ref # 14)	480J1300	1