

1983 KLT200 PARTS DIAGRAM

CRANKSHAFT/BALANCER

E1321-0042

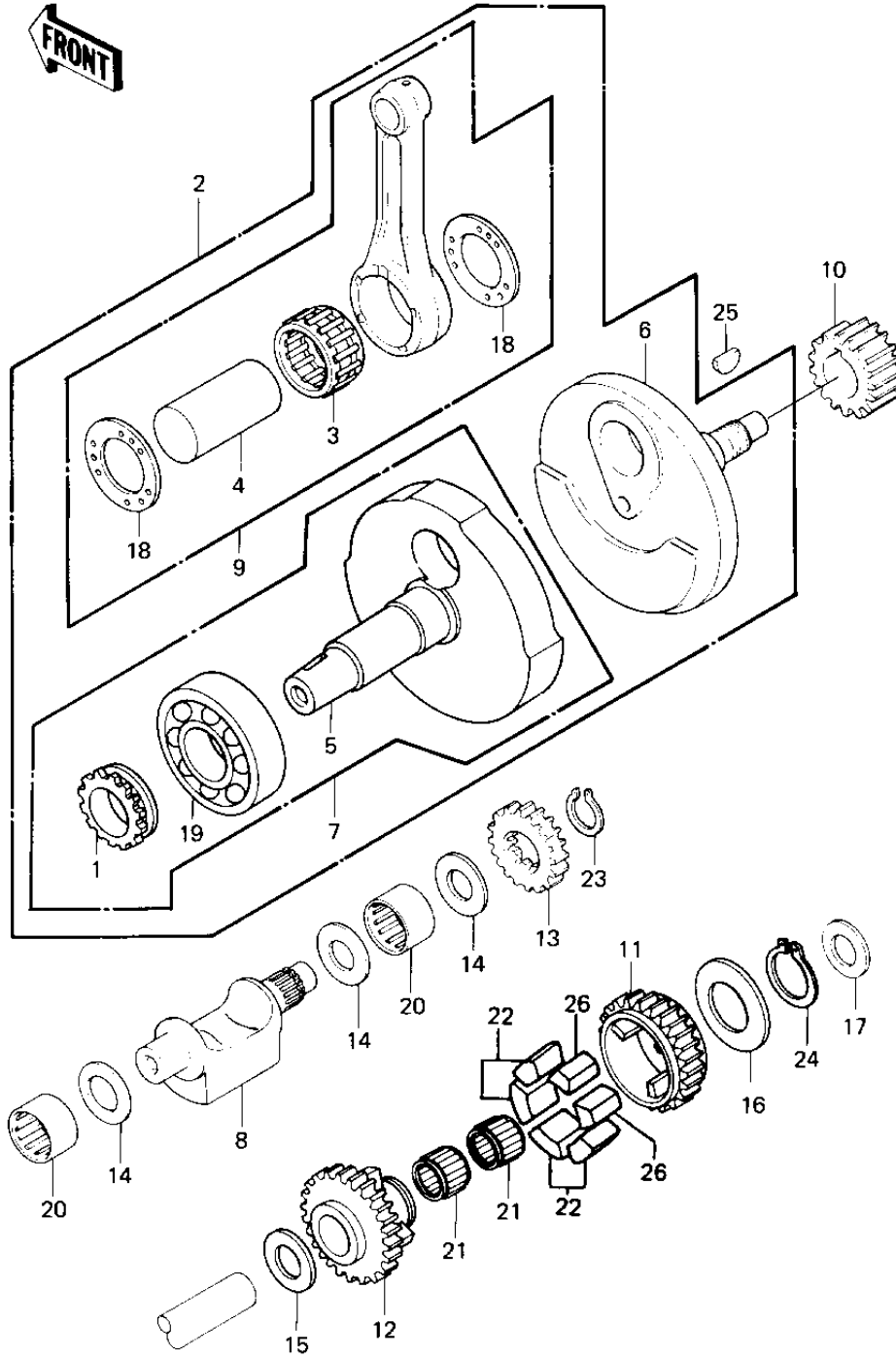

1983 KLT200 PARTS LIST

CRANKSHAFT/BALANCER

ITEM NAME	PART NUMBER	QUANTITY
SPROCKET,16T (Ref # 1)	12046-1038	1
CRANKSHAFT-COMP (Ref # 2)	13031-1082	1
BEARING-BIG END (Ref # 3)	13034-1013	1
PIN-CRANK (Ref # 4)	13035-1009	1
CRANKSHAFT,LH (Ref # 5)	13037-1155	1
CRANKSHAFT,RH (Ref # 6)	13037-1156	1
CRANKSHAFT (Ref # 7)	13037-5007	1
BALANCER (Ref # 8)	13041-1003	1
SET-CONNECTING ROD (Ref # 9)	13044-5029	1
GEAR-PRIMARY SPUR,21T (Ref # 10)	13097-1067	1
GEAR-TRANSMISSION SPU (Ref # 11)	13129-1364	1
GEAR-TRANSMISSION SPU (Ref # 12)	13129-1365	1
GEAR-TRANSMISSION SPU (Ref # 13)	13129-1366	1
WASHER,20X36X1 (Ref # 14)	92022-1366	1
WASHER,16X34X1 (Ref # 15)	92022-1367	1
WASHER,25.3X44X1 (Ref # 16)	92022-1390	1
WASHER,16.3X25X1 (Ref # 17)	92022-1391	1
SPACER (Ref # 18)	92026-1070	1
BEARING,BALL,#6306 (Ref # 19)	92045-037	1
BEARING-NEEDLE,NK20/1 (Ref # 20)	92046-1183	1
BEARING-NEEDLE,K16X20 (Ref # 21)	92046-1053	1
DAMPER,IDLER GEAR (Ref # 22)	92075-1595	1
CIRCLIP, 20MM (Ref # 23)	480J2000	1
CIRCLIP,25M/M (Ref # 24)	480J2500	1
WOODRUFF KEY (Ref # 25)	510A5100	1
DAMPER,IDLER GEAR (Ref # 26)	92075-1596	1