

1982 KE125 PARTS DIAGRAM

BRAKE PEDAL/TORQUE LINK ('82-'83 A9/A10)

F2260-0034

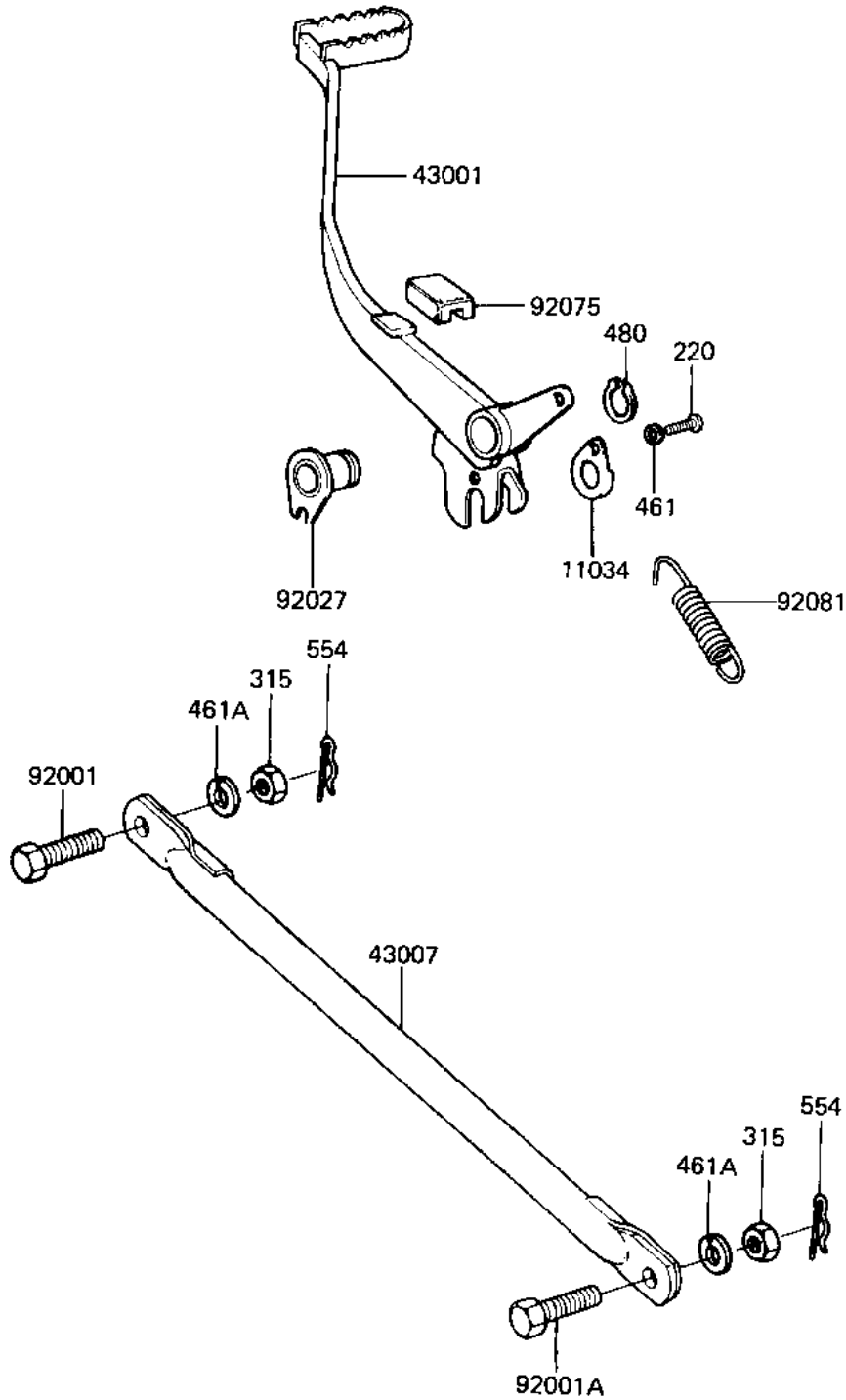

1982 KE125 PARTS LIST

BRAKE PEDAL/TORQUE LINK ('82-'83 A9/A10)

ITEM NAME	PART NUMBER	QUANTITY
PLATE (Ref # 11034)	43081-002	1
PEDAL,BRAKE (Ref # 43001)	43001-058	1
TORQUE LINK,REAR BRAK (Ref # 43007)	43007-048	1
BOLT HEX HEAD 10X25 (Ref # 92001)	92003-003	1
BOLT TORQUE LINK FIT (Ref # 92001A)	92003-017	1
COLLAR,BRAKE PEDAL (Ref # 92027)	92027-210	1
DAMPER RUBBER,BK PDL (Ref # 92075)	92075-220	1
SPRING BRAKE PEDAL (Ref # 92081)	43005-032	1
SCREW PAN HEAD 5X8 (Ref # 220)	220B0508	1
NUT 10MM (Ref # 315)	315B1000	1
WASHER SPRING 5MM (Ref # 461)	461F0500	1
WASHER SPRING 10MM (Ref # 461A)	461F1000	1
CIRCLIP,22MM (Ref # 480)	480J2200	1
PIN,SNAP (Ref # 554)	554A0800	1