

1999 NINJA® 500R PARTS DIAGRAM

Seat

F2510

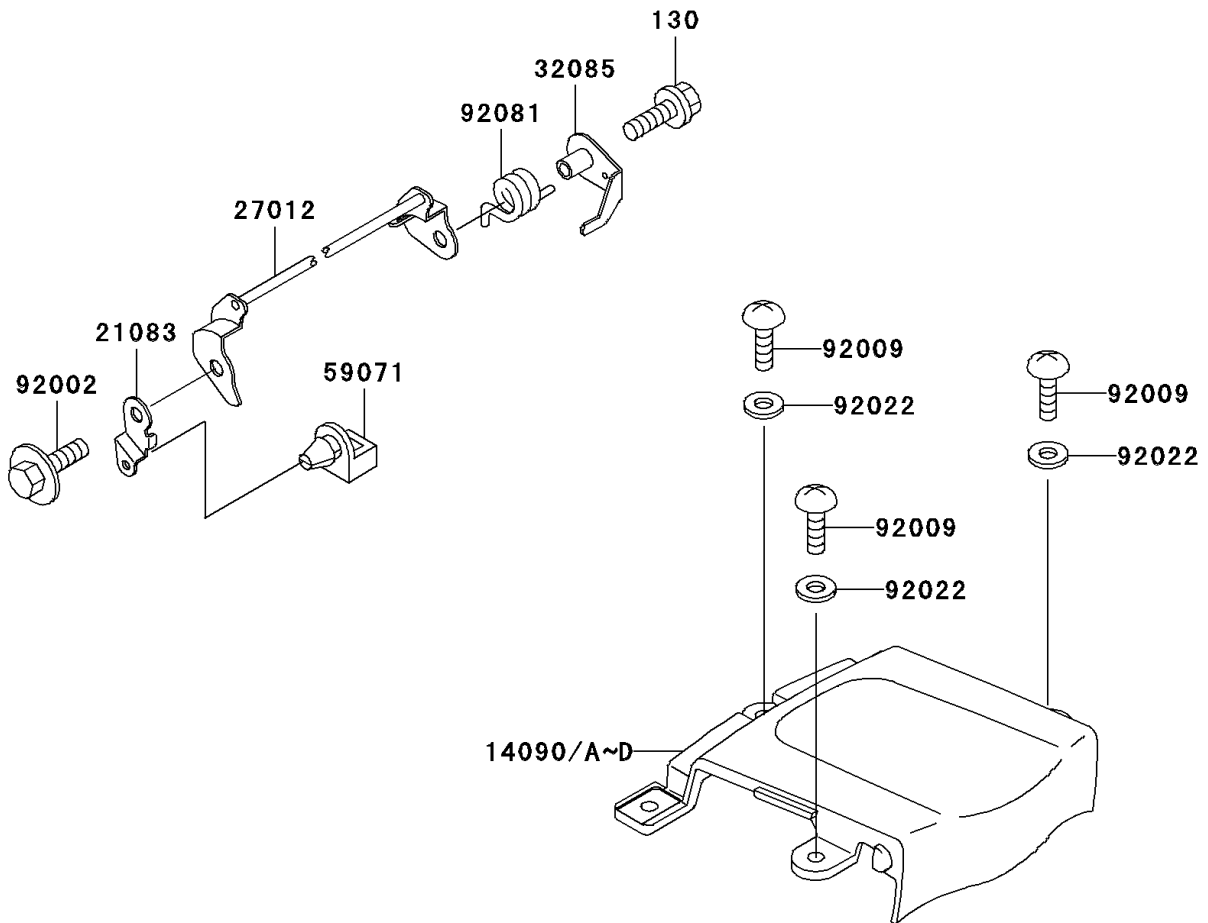
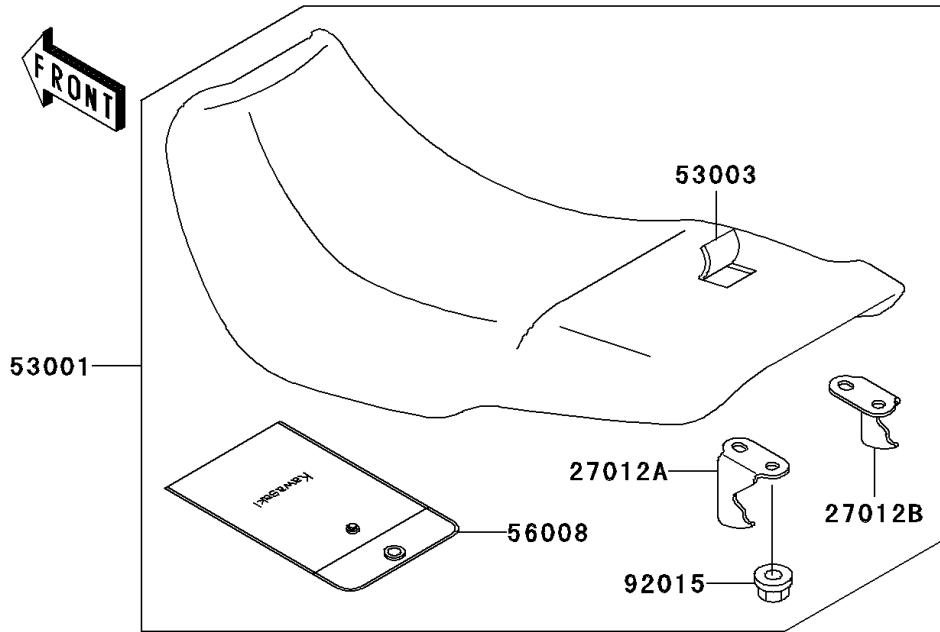

1999 NINJA® 500R PARTS LIST

Seat

ITEM NAME	PART NUMBER	QUANTITY
BOLT-FLANGED,6X25 (Ref # 130)	130J0625	1
COVER,SEAT,F.RED (Ref # 14090)	14090-1369-B1	1
ARM,SEAT LOCK (Ref # 21083)	21083-1063	1
HOOK,SEAT LOCK (Ref # 27012)	27012-1363	1
HOOK,SEAT,LH (Ref # 27012A)	27012-1377	1
HOOK,SEAT,RH (Ref # 27012B)	27012-1378	1
STOPPER,SEAT LOCK SPRING (Ref # 32085)	32085-1270	1
SEAT-ASSY,DUAL,BLACK (Ref # 53001)	53001-1726-MA	1
LEATHER,SEAT,BLACK (Ref # 53003)	53003-1284-MA	1
BAG,HAND BOOK (Ref # 56008)	56008-1066	1
JOINT (Ref # 59071)	59071-1103	1
BOLT,6X12 (Ref # 92002)	92002-1884	1
SCREW,5X16,BLACK (Ref # 92009)	92009-1654	1
NUT,FLANGED,6MM (Ref # 92015)	92015-1078	1
WASHER,NYLON,5.3X11.5X1.5 (Ref # 92022)	92022-1521	1
SPRING (Ref # 92081)	92081-1982	1