

1996 NINJA® 250R PARTS DIAGRAM

Handlebar

F2310

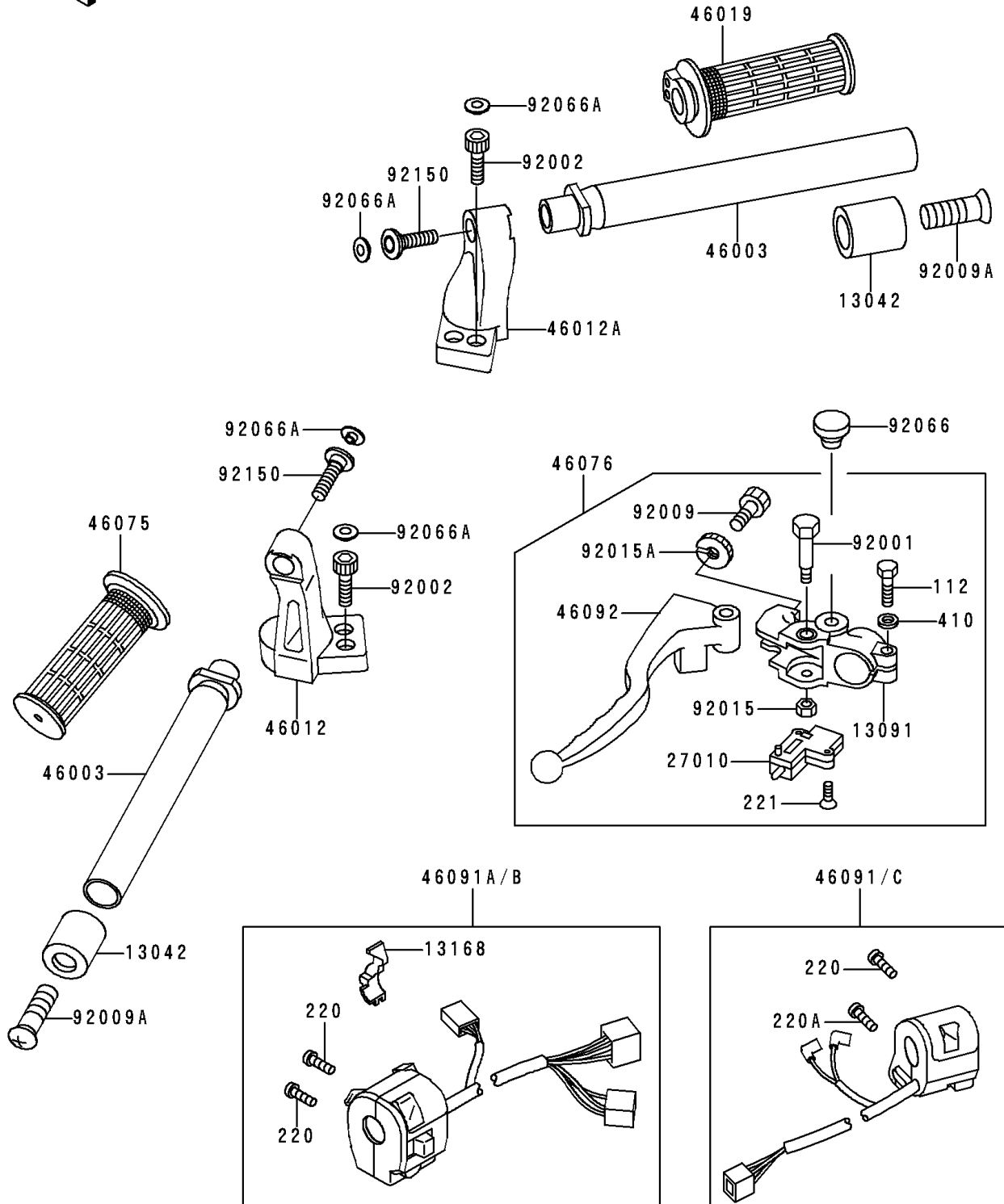

1996 NINJA® 250R PARTS LIST

Handlebar

ITEM NAME	PART NUMBER	QUANTITY
BOLT-UPSET,6X22 (Ref # 112)	112C0622	1
SCREW-PAN-CROS (Ref # 220)	220C0525	1
SCREW-PAN-CROS (Ref # 220A)	220C0540	1
SCREW-CSK-CROS (Ref # 221)	221C0316	1
WASHER-PLAIN-SMALL,6MM,BLACK (Ref # 410)	410F0600	1
WEIGHT,HANDLE (Ref # 13042)	13042-1069	1
HOLDER,CLUTCH LEVER (Ref # 13091)	13091-1272	1
LEVER,CHOKE (Ref # 13168)	13168-1516	1
SWITCH,CLUTCH,BLACK (Ref # 27010)	27010-1094	1
HANDLE (Ref # 46003)	46003-1280	1
HOLDER-HANDLE,LH (Ref # 46012)	46012-1183	1
HOLDER-HANDLE,RH (Ref # 46012A)	46012-1184	1
GRIP-ASSY,THROTTLE (Ref # 46019)	46019-1077	1
GRIP,LH (Ref # 46075)	46075-1088	1
LEVER-ASSY-GRIP,CLUTCH (Ref # 46076)	46076-1105	1
HOUSING-ASSY-CONTROL,RH (Ref # 46091)	46091-1663	1
HOUSING-ASSY-CONTROL,LH (Ref # 46091A)	46091-1664	1
LEVER-GRIP,CLUTCH (Ref # 46092)	46092-1103	1
BOLT,CLUTCH LEVER,BLACK (Ref # 92001)	92001-1548	1
BOLT,SOCKET,8X20 (Ref # 92002)	92002-1178	1
SCREW,CABLE ADJUST,8MM,BLACK (Ref # 92009)	92009-1134	1
SCREW,8X45 (Ref # 92009A)	92009-1257	1
NUT,LOCK,6MM,BLACK (Ref # 92015)	92015-1191	1
NUT,CABLE ADJUST LOCK,8MM,BLK (Ref # 92015A)	92015-1197	1
PLUG,9.5X8,POLYETHYLENE (Ref # 92066)	92066-1077	1
PLUG (Ref # 92066A)	92066-1216	1
BOLT,SOCKET,8X30 (Ref # 92150)	92150-1771	1