

1996 NINJA® 250R PARTS DIAGRAM

Cylinder Head

E1111

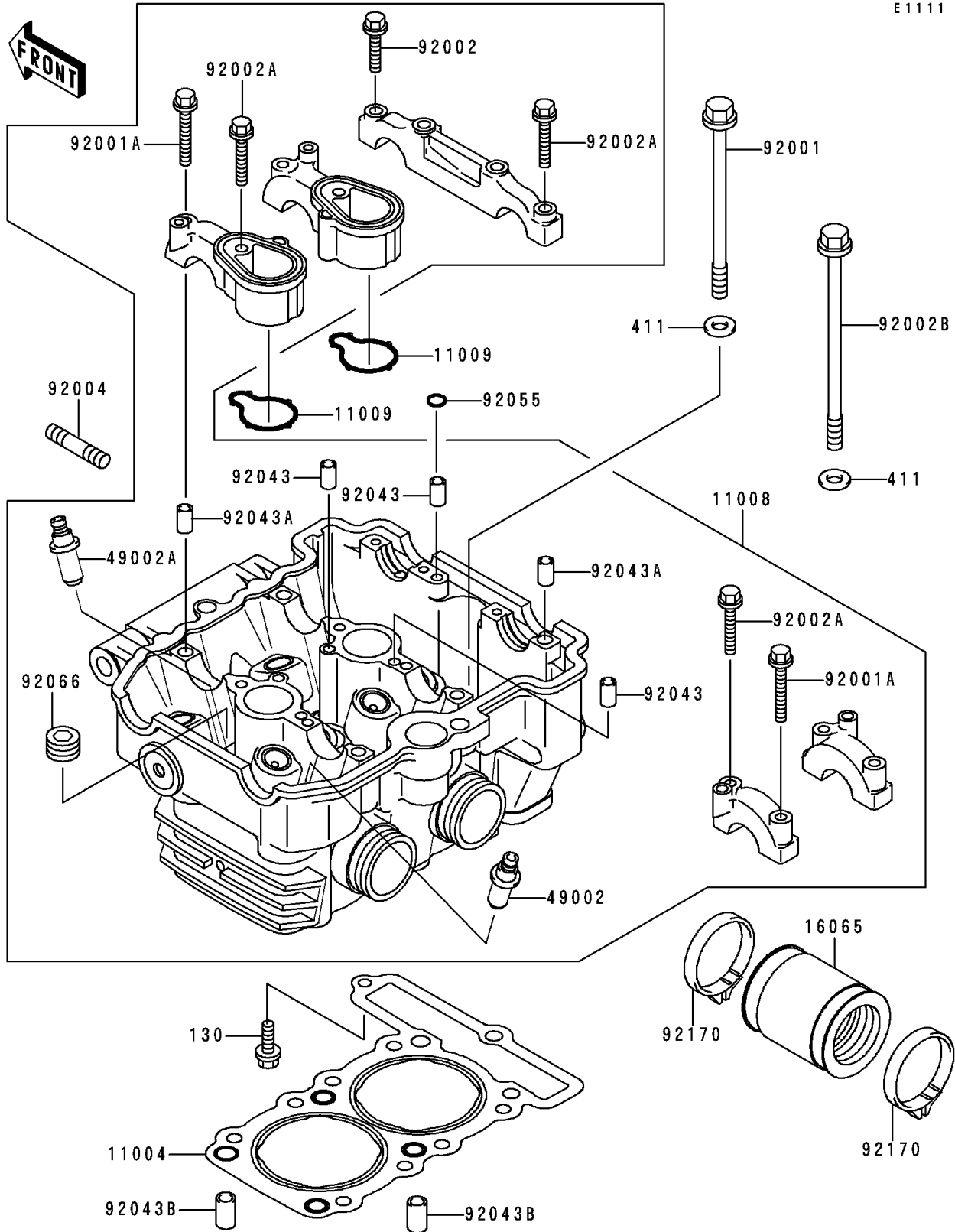

1996 NINJA® 250R PARTS LIST

Cylinder Head

ITEM NAME	PART NUMBER	QUANTITY
BOLT-FLANGED,6X25 (Ref # 130)	130J0625	1
WASHER-PLAIN,8MM (Ref # 411)	411B0800	1
GASKET-HEAD (Ref # 11004)	11004-1312	1
HEAD-COMP-CYLINDER (Ref # 11008)	11008-1201	1
GASKET,CAMSHAFT BRACKET (Ref # 11009)	11009-1573	1
HOLDER-CARBURETOR (Ref # 16065)	16065-1156	1
GUIDE-VALVE,INTAKE (Ref # 49002)	49002-1070	1
GUIDE-VALVE,EXHAUST (Ref # 49002A)	49002-1071	1
BOLT,8X115 (Ref # 92001)	92001-1481	1
BOLT,6X46 (Ref # 92001A)	92001-1872	1
BOLT,6X30 (Ref # 92002)	92002-1755	1
BOLT,6X40 (Ref # 92002A)	92002-1756	1
BOLT,8X146 (Ref # 92002B)	92002-1832	1
STUD,6X27 (Ref # 92004)	92004-066	1
PIN,4.2X6X12 (Ref # 92043)	92043-1262	1
PIN,6.2X8X14 (Ref # 92043A)	92043-1263	1
PIN,8.2X10X14 (Ref # 92043B)	92043-1264	1
RING-O,5.5X1.5 (Ref # 92055)	92055-1339	1
PLUG (Ref # 92066)	92066-1253	1
CLAMP (Ref # 92170)	92170-1438	1