

2000 W650 PARTS DIAGRAM

Oil Pump/Oil Filter

E1710

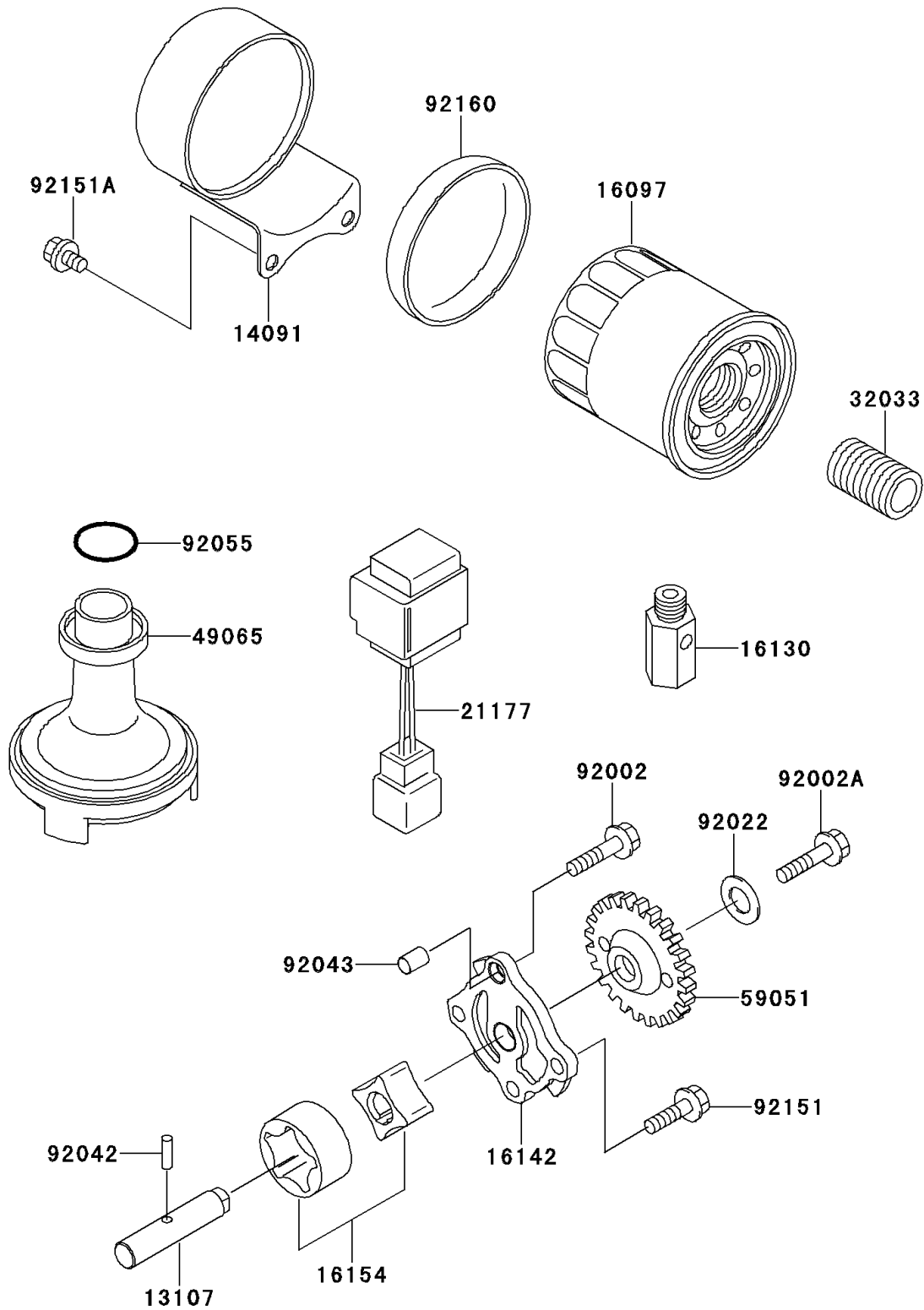

2000 W650 PARTS LIST

Oil Pump/Oil Filter

ITEM NAME	PART NUMBER	QUANTITY
SHAFT,OIL PUMP (Ref # 13107)	13107-1411	1
COVER,OIL FILTER (Ref # 14091)	14091-1357	1
FILTER-ASSY-OIL (Ref # 16097)	16097-1068	1
VALVE-ASSY-RELIEF (Ref # 16130)	16130-1058	1
COVER-PUMP,OIL (Ref # 16142)	16142-1155	1
ROTOR-PUMP (Ref # 16154)	16154-1115	1
CONTROLLER,OIL LAMP (Ref # 21177)	21177-1058	1
PIPE,OIL FILTER (Ref # 32033)	32033-1535	1
FILTER-OIL (Ref # 49065)	49065-1082	1
GEAR-SPUR,OIL PUMP (Ref # 59051)	59051-1377	1
BOLT,6X25 (Ref # 92002)	92002-1344	1
BOLT,6X25 (Ref # 92002A)	92002-1582	1
WASHER,6X12.8X1.2 (Ref # 92022)	92022-1827	1
PIN,DOWEL,4X15.8 (Ref # 92042)	92042-014	1
PIN,DOWEL,8X10 (Ref # 92043)	92043-1302	1
RING-O,OIL FILTER (Ref # 92055)	92055-1354	1
BOLT,6X18 (Ref # 92151)	92151-1498	1
BOLT,6X10 (Ref # 92151A)	92151-1502	1
DAMPER,OIL FILTER COVER (Ref # 92160)	92160-1995	1